

Multiple Dwelling Units



Multiple Dwelling Units

APPLICATION

- Providing professional home cabling components to meet all your demands. Simple and convenient home networking is virtually on any applicaton.
- Creating a distribution point for data, voice, audio, and video applications.

FEATURES

- Compatible with ANSI/TIA-568.2-D CAT 5e and CAT 6 performance.
- Multiple knock-outs on top and bottom facilitate cable entry and routing.
- Single-gang and Double-gang modules for your choice.

STANDARDS





- TIA-570 residential wiring standard specifies T568A color code wiring
- UL 1863 safety listed
- ANSI/TIA-568.2-D
- UL 94V-0 flammability standard

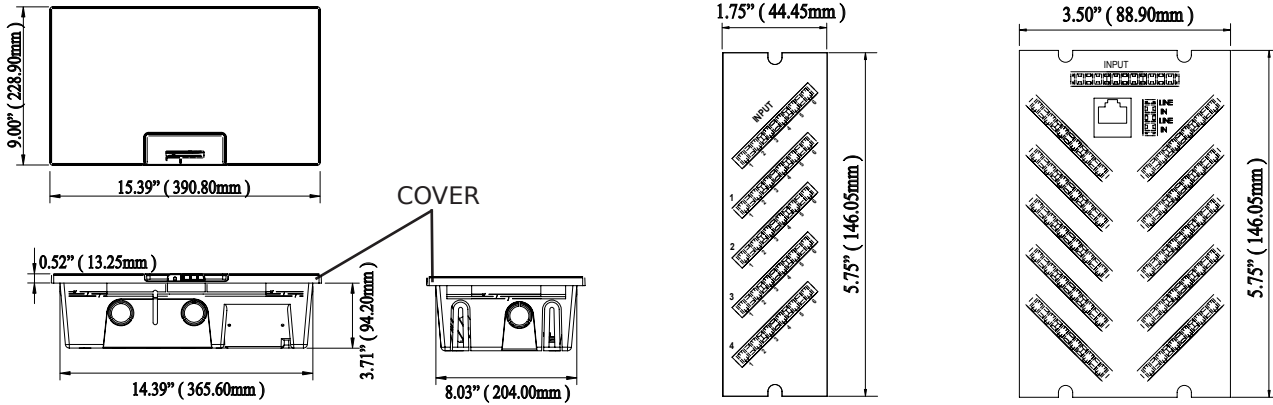





Mechanical Drawing



Multiple Dwelling Units

PART NO.	Application	Features
5210B-6		
	CAT 5e Voice & Data Board For Data, Telephone, Fax, Modem	-6 locations for phone or data connections -4-Pair 110 IDC punchdowns -6 Ports for CAT 5e performance
5220B-6M		
	CAT 6 Voice & Data Board For Data, Telephone, Fax, Modem	-6 locations for phone or data connections -4-Pair 110 IDC punchdowns -6 Ports for CAT 6 performance
5130B-9		
	1x9 Bridged Telephone Board For Telephone, Fax, Modem	-4-Pair 110 IDC punchdowns -Bridge 4 telephone lines to 9 locations -Per line connects to 9 separate telephones
5120B-6		
	1x6 Bridged Telephone Board For Telephone, Fax, Modem	-Bridge 4 telephone lines to 6 locations -Per line connects to 6 separate telephones -RJ-45 expansion port
5510B-4		
	Combo phone & Data Board For Data, Telephone	-1x4 IDC punchdowns for 4-Port telephone lines to 4 locations -4 Ports for CAT 5e data connections via RJ-45 connectors and 4-Pair 110 IDC punchdowns -Data and telephone connections on one board

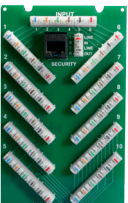
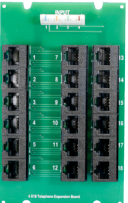
PART NO.	Application	Features
5520B-4M		
	<p>Combo phone & Data Board</p> <p>For Data, Telephone</p>	<p>-1x4 IDC punchdowns for 4-Port telephone lines to 4 locations</p> <p>-4 Ports for CAT 6 data connections via RJ-45 connectors and 4-Pair 110 IDC punchdowns</p> <p>-Data and telephone connections on one board</p>
5230B-6		
	<p>Telephone expansion Board</p> <p>For Telephone, Fax, Modem</p>	<p>-One incoming 4-Pair 110 IDC punchdown</p> <p>-6 outgoing RJ-45 connectors</p> <p>-Bridge 4 telephone lines to 6 locations</p>
5110B-4		
	<p>1x4 Bridged Telephone Board</p> <p>For Telephone, Fax, Modem</p>	<p>-Bridge 6 lines to 4 locations via 110 IDC punchdowns</p>
5140B-6		
	<p>1x6 Bridged Telephone Board</p> <p>For Telephone, Fax, Modem</p>	<p>-Bridge 4 lines to 6 locations via 110 IDC punchdowns</p> <p>-RJ-31 Security port</p>
5150B-10		
	<p>1x10 Bridged Telephone Board</p> <p>For Telephone, Fax, Modem</p>	<p>-Bridge 6 telephone lines to 10 locations via 110 IDC punchdowns</p> <p>-Security port via RJ-45 & 110 IDC punchdowns</p>
5240B-18		
	<p>4x18 Telephone Expansion Board</p> <p>For Telephone, Fax</p>	<p>-Bridge 4 telephone lines to 18 locations</p>

MDU Reference Guide		
PART NO.	Voice Ports	Video Ports
5913-8-019	9-Port	2 GHz, 6-Port

